

StickIt! LED Digits Manual

*How to install and use your new
StickIt! LED Digits Module*

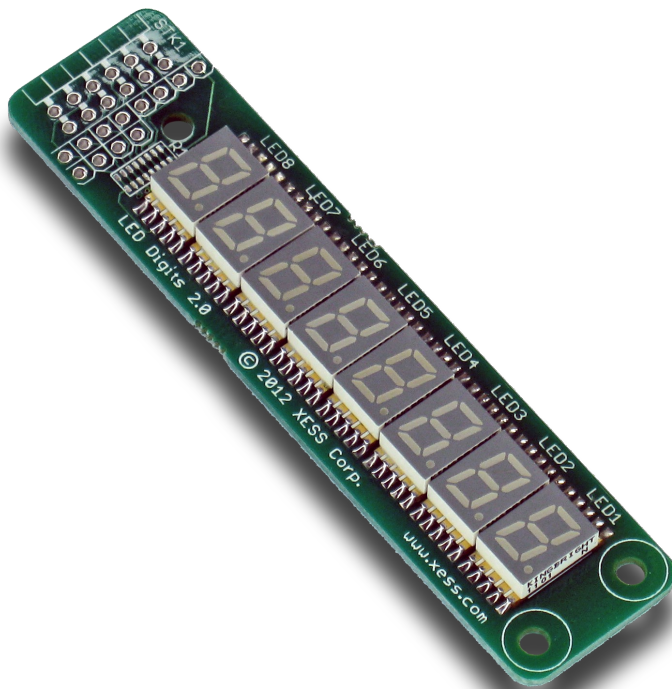

XESS is disclosing this Document and Intellectual Property (hereinafter “the Design”) to you for use in the development of designs to operate on, or interface with XESS hardware devices. XESS expressly disclaims any liability arising out of the application or use of the Design. XESS reserves the right to make changes, at any time, to the Design as deemed desirable in the sole discretion of XESS. XESS assumes no obligation to correct any errors contained herein or to advise you of any correction if such be made. XESS will not assume any liability for the accuracy or correctness of any engineering or technical support or assistance provided to you in connection with the Design.

THE DESIGN IS PROVIDED “AS IS” WITH ALL FAULTS, AND THE ENTIRE RISK AS TO ITS FUNCTION AND IMPLEMENTATION IS WITH YOU. YOU ACKNOWLEDGE AND AGREE THAT YOU HAVE NOT RELIED ON ANY ORAL OR WRITTEN INFORMATION OR ADVICE, WHETHER GIVEN BY XESS, OR ITS AGENTS OR EMPLOYEES. XESS MAKES NO OTHER WARRANTIES, WHETHER EXPRESS, IMPLIED, OR STATUTORY, REGARDING THE DESIGN, INCLUDING ANY WARRANTIES OF MERCHANTABILITY, FITNESS FOR A PARTICULAR PURPOSE, TITLE, AND NONINFRINGEMENT OF THIRD-PARTY RIGHTS.

IN NO EVENT WILL XESS BE LIABLE FOR ANY CONSEQUENTIAL, INDIRECT, EXEMPLARY, SPECIAL, OR INCIDENTAL DAMAGES, INCLUDING ANY LOST DATA AND LOST PROFITS, ARISING FROM OR RELATING TO YOUR USE OF THE DESIGN, EVEN IF YOU HAVE BEEN ADVISED OF THE POSSIBILITY OF SUCH DAMAGES. THE TOTAL CUMULATIVE LIABILITY OF XESS IN CONNECTION WITH YOUR USE OF THE DESIGN, WHETHER IN CONTRACT OR TORT OR OTHERWISE, WILL IN NO EVENT EXCEED THE AMOUNT OF FEES PAID BY YOU TO XESS HEREUNDER FOR USE OF THE DESIGN. YOU ACKNOWLEDGE THAT THE FEES, IF ANY, REFLECT THE ALLOCATION OF RISK SET FORTH IN THIS AGREEMENT AND THAT XESS WOULD NOT MAKE AVAILABLE THE DESIGN TO YOU WITHOUT THESE LIMITATIONS OF LIABILITY.

The Design is not designed or intended for use in the development of on-line control equipment in hazardous environments requiring fail-safe controls, such as in the operation of nuclear facilities, aircraft navigation or communications systems, air traffic control, life support, or weapons systems (“High-Risk Applications”). XESS specifically disclaims any express or implied warranties of fitness for such High-Risk Applications. You represent that use of the Design in such High-Risk Applications is fully at your risk.

© 2013 XESS, Inc. XESS, the XESS logo, and other designated brands included herein are trademarks of XESS Corporation. PMOD is a trademark of Digilent Inc. All other trademarks are the property of their respective owners.



This document is licensed under the Attribution-ShareAlike 3.0 Unported license, available at <http://creativecommons.org/licenses/by-sa/3.0/>.

StickIt! LED Digits Manual
MAN003 (V2.0) Dave VandeboutDave VandeboutDave VandeboutDave
VandeboutOctober 17, 2013

The following table shows the revision history for this document.

Date	Version	Revision
01/18/2012	1.0	Initial release for StickIt! LED Digits module V1.0.
10/17/2013	2.0	Schematic and image changes for StickIt! LED Digits module V2.0.

Table of Contents

- C.1 Preliminaries..... 1**
 - Getting Help!..... 1
 - Take Notice!..... 1
 - Packing List..... 1
- C.2 Setup..... 2**
 - Inserting Your StickIt! LED Digits Module Into Your StickIt! Board..... 2
 - Inserting Into a PMOD Socket..... 2
 - Inserting Into a Wing Socket..... 3
- C.3 Operation..... 5**
- C.4 Using the Module..... 7**
- A.1 I/O Locations..... 8**
- A.2 Schematic..... 9**

C.1 Preliminaries

Here's some helpful information before getting started.

Getting Help!

Here are some places to get help if you encounter problems:

- If you can't get the StickIt! LED Digits module to work, send an e-mail message describing your problem to help@xess.com or submit a problem report at <http://www.xess.com/help.php>. Our web site also has
 - answers to frequently-asked-questions,
 - example designs, application notes and tutorials,
 - a forum where you can post questions.

Take Notice!

It's pretty hard to get in trouble with this module.

Packing List

Here is what you should have received in your package:

- a StickIt! LED Digits module.
- PMOD™ male header.
- Wing male headers (8-pin & 4-pin).

C.2 Setup

The StickIt! LED Digits module provides a row of eight seven-segment LED digits that you can insert into an eight-bit PMOD or Wing socket on your StickIt! board.

Inserting Your StickIt! LED Digits Module Into Your StickIt! Board

Inserting Into a PMOD Socket

To use the StickIt! LED Digits module with a PMOD socket, first solder the included male PMOD header to the module as shown. (**To insure a stable connection, only use a header with 0.025" square pins.**)

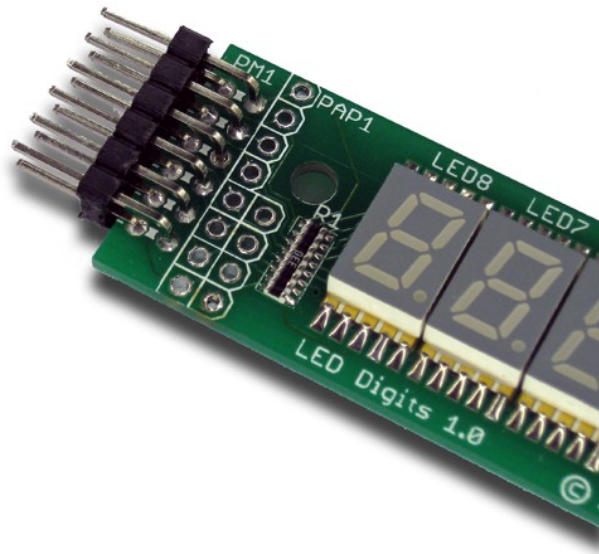

Then insert the module into one of the eight-bit PMOD sockets on the StickIt! Board. (This module does not directly connect to any power supply so there is no need to change the setting of the voltage selection jumper of the PMOD socket.)

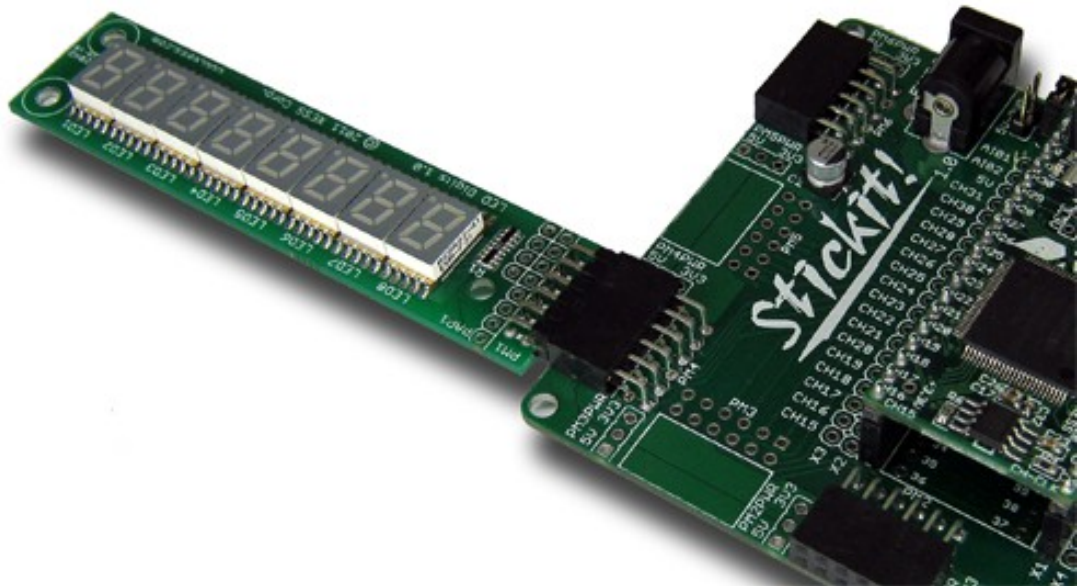

Inserting Into a Wing Socket

To use the StickIt! LED Digits module with a Wing socket, first solder the included male Wing headers to the module as shown. (**To insure a stable connection, only use a header with 0.025" square pins.**)



Then insert the module into one of the eight-bit Wing sockets on the StickIt! board.

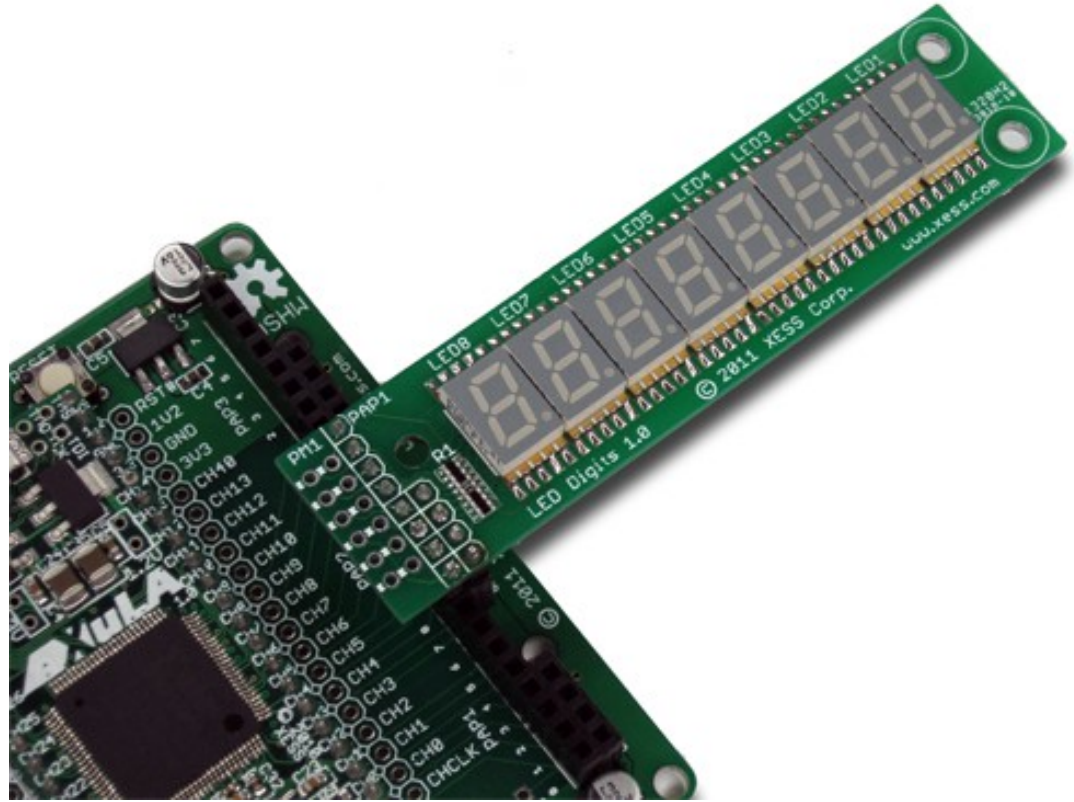

C.3 Operation

This chapter describes the operation of the StickIt! LED Digits module using a simplified schematic. You can find a complete [schematic](#) at the end of this manual.

A total of 56 LED segments are distributed over the eight digits on the module. All these segments can be controlled with only eight I/O signals by using [Charlieplexing](#). You can see how this works by examining the operation of just two of the LED digits on the module.

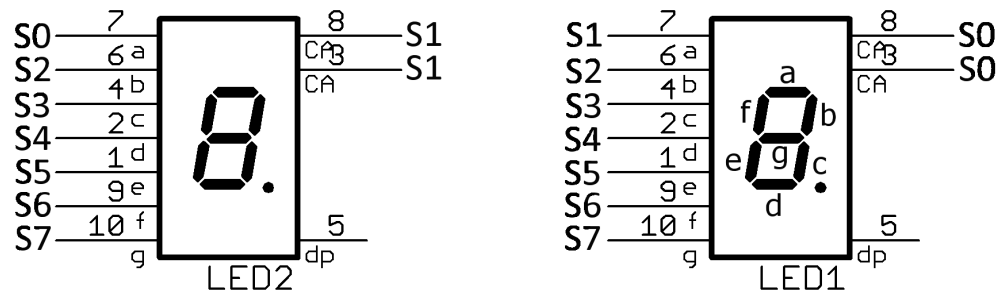

To light up digit LED1, the common anode pin (CA) is driven high by signal S0. This will serve as the source of the current for any segments in this digit that are turned on. To turn on a segment, the corresponding signal is pulled to ground. For example, to turn on segments b and c, signals S2 and S3 are pulled low. To keep the other segments off, the rest of the signals are placed in a high-impedance state so there is no current path through them. Note that only one signal is at a high level (S0) and all the others are either pulled low or in a high-impedance state. Because of this, no segments in LED2 will be on because its CA pin (driven by signal S1) will never be driven high while LED1 is active.

In a similar manner, when digit LED2 is activated by driving signal S1 high and grounding or tristating signals S0 and S2-S7, then LED1 will be inactive because S0 will never be driven high.

By rapidly switching the activation back-and-forth between digits LED1 and LED2, persistence-of-vision (POV) will make it appear that the sixteen segments are displaying a static pattern even though only eight signals are used to drive them. This technique can be extended across all eight of the LED digits. A table of the signal connections to the pins controlling the segments of each digit is shown below.

Pin	LED1	LED2	LED3	LED4	LED5	LED6	LED7	LED8
CA	S0	S1	S2	S3	S4	S5	S6	S7
a	S1	S0	S0	S0	S0	S0	S0	S0
b	S2	S2	S1	S1	S1	S1	S1	S1
c	S3	S3	S3	S2	S2	S2	S2	S2
d	S4	S4	S4	S4	S3	S3	S3	S3
e	S5	S5	S5	S5	S5	S4	S4	S4
f	S6	S6	S6	S6	S6	S6	S5	S5
g	S7	S7	S7	S7	S7	S7	S7	S6

C.4 *Using the Module*

To use the StickIt! LED Digits module, you will need to do the following:

- Create a Xilinx ISE FPGA project and write some HDL code for Charlieplexing the LED digits.
- Attach the module to either a PMOD or Wing socket on the StickIt! board.
- Determine the channel signals on the PMOD or Wing socket that connect to each I/O pin of the module.
- Find which FPGA pin of the XuLA board connects to each channel signal.
- Make a UCF file associating each FPGA pin with an I/O pin of the module.
- Include the UCF file in your ISE project.

That's a lot of work just to display some simple digits, so we've done most of it for you. Just go to <http://github.com/xesscorp/StickIt>. There, you will find a subdirectory with a Xilinx ISE project that includes:

- a Charlieplexing HDL module,
- an example that uses the Charlieplexing module for displaying data on a StickIt! LED Digits module,
- and a UCF file containing the FPGA pin assignments to use when installing the StickIt! LED Digits module into any of the PMOD or Wing sockets.

A.1 I/O Locations

The connections of the I/O signals to the PMOD and Wing headers of the StickIt! LED Digits module are shown below.

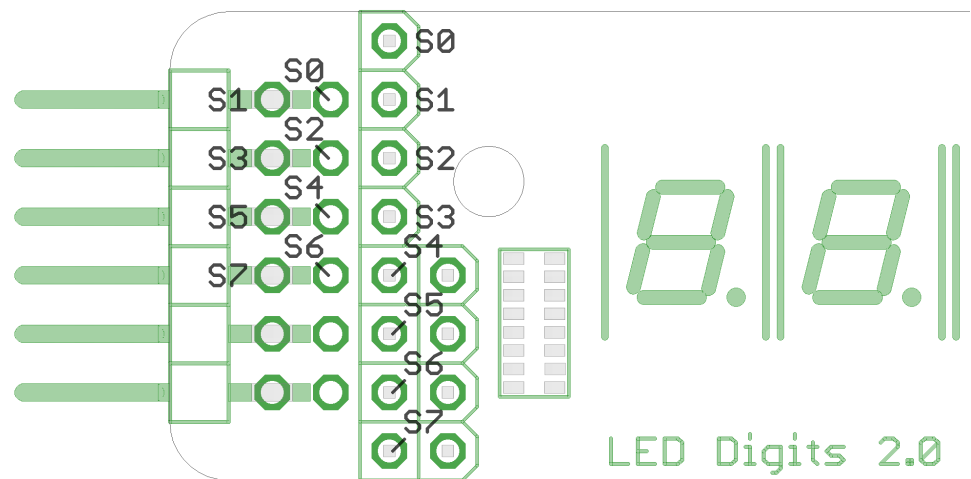

A.2 Schematic

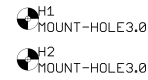
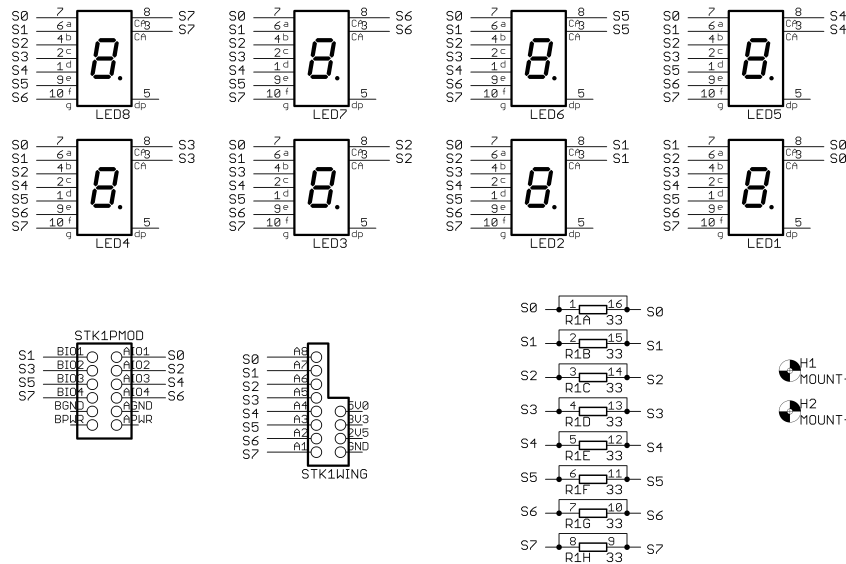

© 2012, XESS Corp. Some rights reserved.

Licensed under a Creative Commons Attribution-ShareAlike Unported License. See creativecommons.org/licenses/by-sa/3.0/

LED Digits		
PROJECT: StickIt-LedDigits	REV: 2.0	Date: 10/16/2013 9:26:36 PM
AUTHOR: Dave Vandenbout / XESS Corp.		Sheet: 1/1